

# Frigerio

## DAVIS SYSTEM SOFA SWING ARMREST

Design R&D Frigerio

Raffinata espressione di un modo di intendere il divano come elemento d'arredo protagonista dell'ambiente, Davis non è un semplice divano, ma un sistema che permette di creare il proprio divano su misura, permettendo di abbinare differenti tipologie di braccioli e scegliendo fra cinque modelli di piedini e tre comfort di seduta. La collezione Davis è caratterizzata da un'estesa gamma di elementi componibili con cuscini schienale rialzabili (patent pending Frigerio) e un'ampia gamma di accessori per realizzazioni uniche. Questo programma di sedute brevettato è altamente versatile con un'ampia modularità che permette lo sviluppo di composizioni lineari o dal ritmo articolato con configurazioni più o meno formali per soddisfare ogni esigenza del vivere moderno.

Il bracciolo **Swing** si caratterizza per una cucitura sartoriale che mette in risalto un meccanismo: un design che sottolinea le linee pulite e precise della collezione Davis, dando vita a un elemento elegante e funzionale al tempo stesso. Una scelta moderna il cui design minimalista sfugge alle classificazioni convenzionali.

Refine expression of a way to interpret the sofa as a leading character of the environment, Davis is not a simple sofa, but a system which allows you to create your made-to-measure sofa, combining different kind of armrests and choosing between five different models of feet and three seat comforts. The Davis collection features a wide range of sectional elements all with back cushions having an integrated raised movement (patent pending Frigerio) and a wide range of accessories for unique realizations. This highly versatile patented pending seating programme allows the development of linear or more articulated compositions with configurations more or less formal to meet the needs of the modern living.

The **Swing** armrest is characterised by a tailored seam that actually highlights a mechanism: a design that emphasizes the clean, precise lines of the Davis collection, resulting in a piece that is both elegant and functional. A modern choice whose minimalist design defies conventional categorisation.

**Struttura:** legno multistrato imbottito in poliuretano espanso indeformabile rivestito in tessuto protettivo accoppiato. Il modello è dotato di piedini centrali di sicurezza.

**Cuscini seduta:** disponibili 3 varianti: GOOSE in piuma d'oca (Assopiuma) con inserto in poliuretano; POLMD in poliuretano espanso indeformabile media densità e fibra sintetica ricoperti con fodera in cotone; POLHD in poliuretano espanso indeformabile alta densità e fibra sintetica ricoperti con fodera in cotone.

**Cuscini schienale:** rialzabili (brevetto Frigerio), in piuma d'oca (Assopiuma) con inserto in poliuretano indeformabile.

**Piedini:** disponibili in 5 differenti varianti: P, M, L, R e T.

**Cuscinetto:** piuma d'oca (Assopiuma).

**Rivestimento:** sfoderabile in tessuto, fisso in pelle.

**Profilo:** esclusivamente sul cuscino seduta, nello stesso materiale e colore del rivestimento. Su richiesta in contrasto esclusivamente in Grosgrain.

**Structure:** plywood padded with non-deformable polyurethane foam covered with doubled protective fabric. The model is provided with central security feet.

**Seat cushions:** available in 3 different variants: GOOSE in goose down (Assopiuma) with core in non-deformable polyurethane foam; POLMD in medium density non-deformable polyurethane foam and synthetic fibre layer covered with cotton fabric; POLHD in hard density non-deformable polyurethane foam and synthetic fibre layer covered with cotton fabric.

**Back cushions:** with adjustable movement in height (Frigerio patent), in goose down (Assopiuma) with core in non-deformable polyurethane foam.

**Feet:** available in 5 different variants: P, M, L, R e T.

**Small cushions:** goose down (Assopiuma).

**Cover:** removable in fabric, fix in leather.

**Piping:** on seat cushion only, in the same material and colour as the cover. On request in contrast exclusively in Grosgrain.

**VERSIONE DAVIS SWING:** Struttura: legno multistrato e meccanismo reclinabile imbottiti in poliuretano espanso indeformabile rivestito in fibra sintetica termolegata con vellutino.

**VERSION DAVIS SWING:** Structure: plywood and metal reclining mechanism padded with non-deformable polyurethane foam covered with synthetic fibre thermo-bonded with velveteen.



## DAVIS SYSTEM

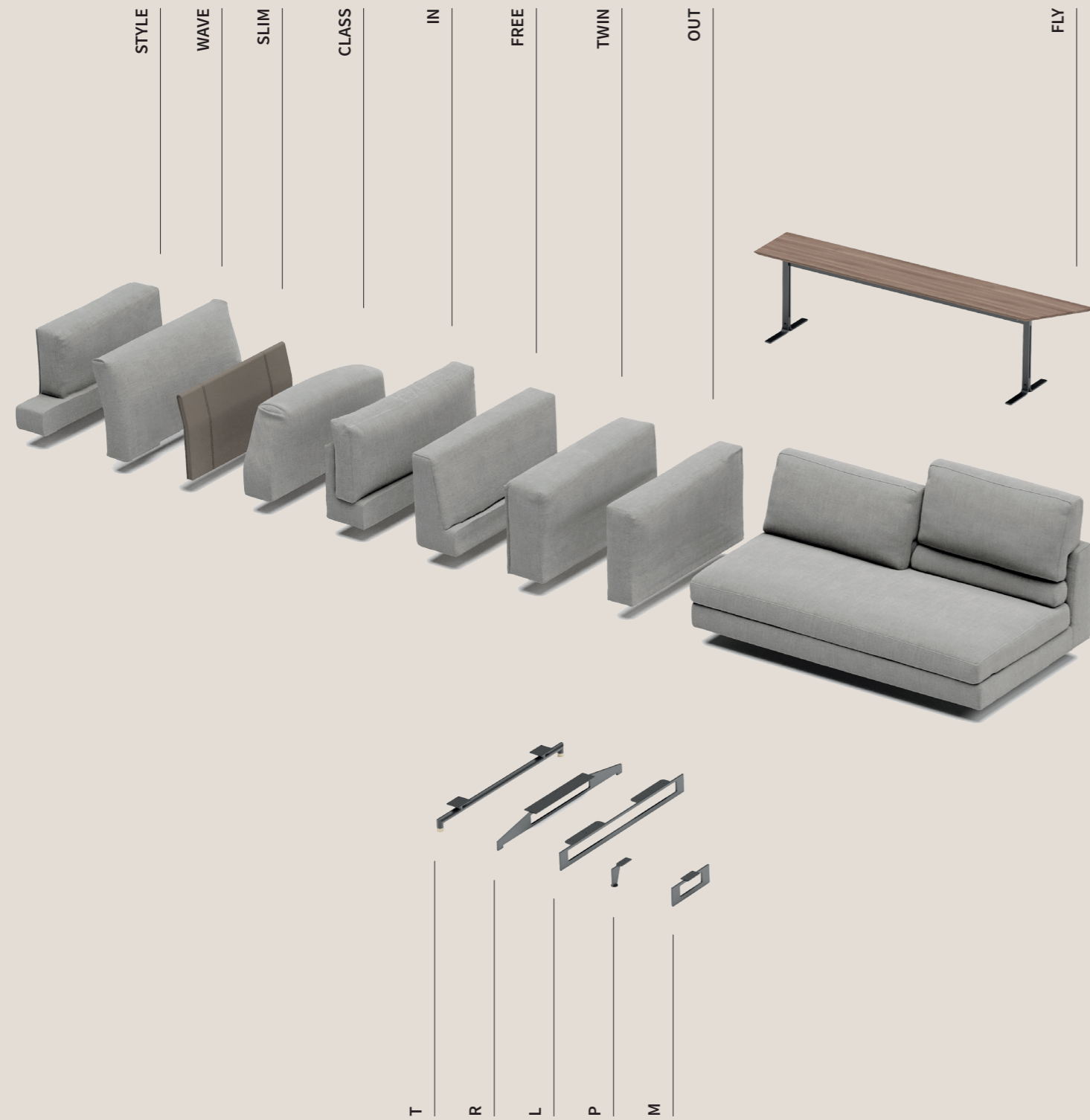

## DAVIS SYSTEM

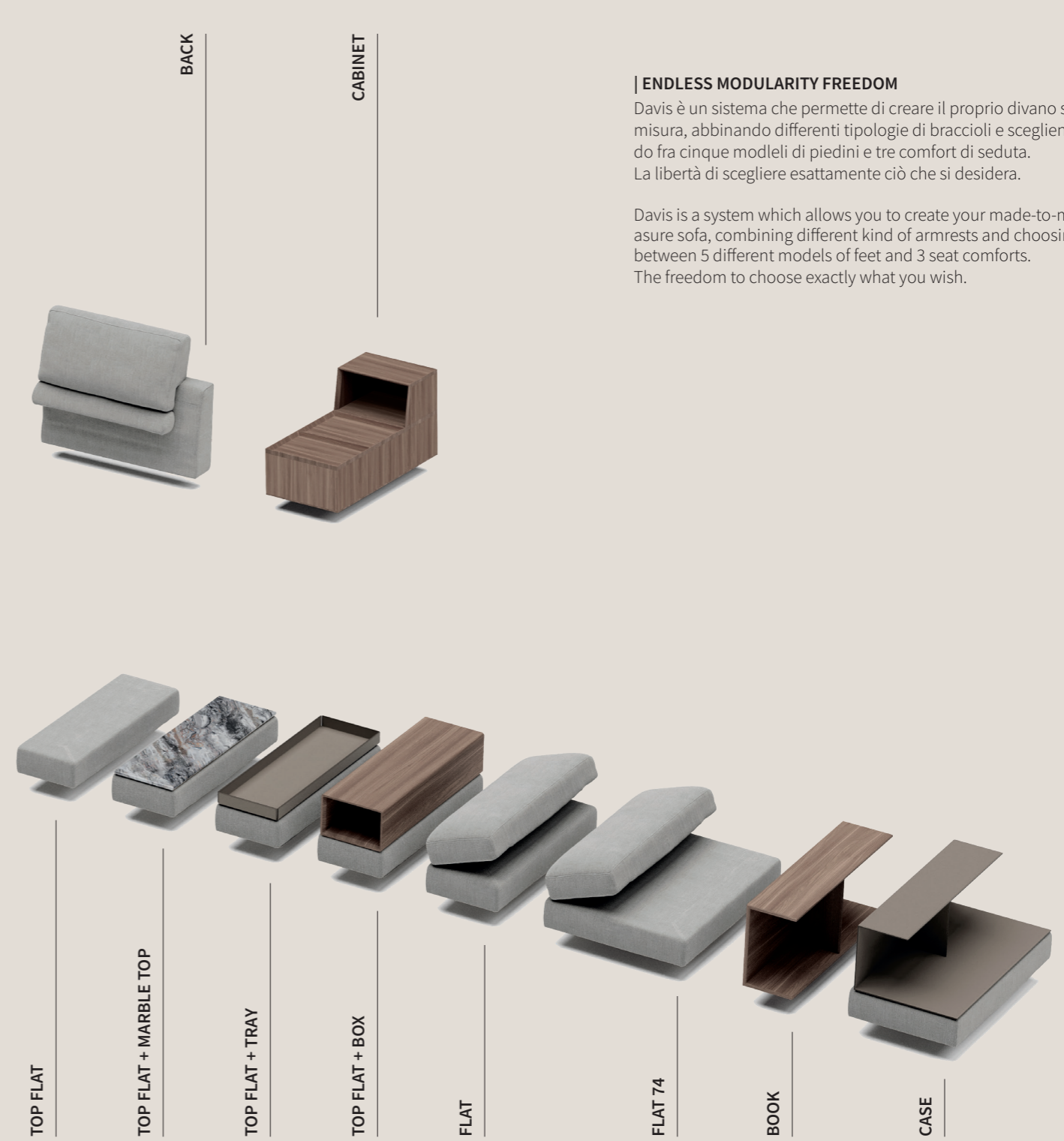

### | ENDLESS MODULARITY FREEDOM

Davis è un sistema che permette di creare il proprio divano su misura, abbinando differenti tipologie di braccioli e scegliendo fra cinque modelli di piedini e tre comfort di seduta. La libertà di scegliere esattamente ciò che si desidera.

Davis is a system which allows you to create your made-to-measure sofa, combining different kind of armrests and choosing between 5 different models of feet and 3 seat comforts. The freedom to choose exactly what you wish.

## DAVIS BRACCIOLI / ARMRESTS

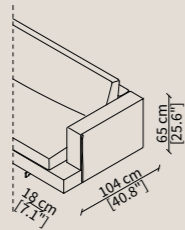

### BRACCIOLO STYLE / ARMREST STYLE

**Struttura:** legno multistrato imbottito in poliuretano.

**Rivestimento:** con cucitura decorativa.

**Structure:** plywood padded with polyurethane foam.

**Cover:** with decorative thick sewing.

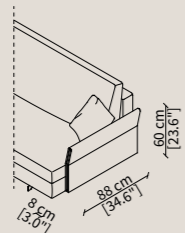

### BRACCIOLO SLIM / ARMREST SLIM

**Struttura:** legno multistrato ricoperto in pelle.

**Cuscino:** piuma d'oca.

**Structure:** plywood covered in leather.

**Cushion:** goose down.

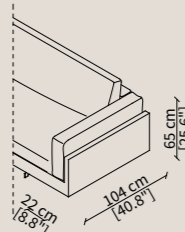

### BRACCIOLO IN / ARMREST IN

**Struttura:** legno multistrato imbottito in poliuretano.

**Cuscino:** piuma d'oca con inserto in poliuretano.

**Structure:** plywood padded with polyurethane foam.

**Cushion:** goose down with core in polyurethane foam.

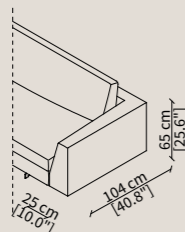

### BRACCIOLO FREE / ARMREST FREE

**Struttura:** legno multistrato imbottito in poliuretano e tessuto protettivo accoppiato.

**Structure:** plywood padded with polyurethane foam and doubled protective fabric.

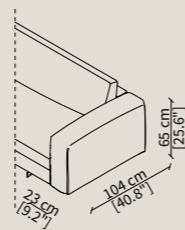

### BRACCIOLO TWIN / ARMREST TWIN

**Struttura:** legno multistrato imbottito in poliuretano e piuma.

**Rivestimento:** con cucitura decorativa.

**Structure:** plywood padded with polyurethane foam and goose down.

**Cover:** with decorative thick sewing.

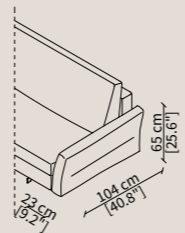

### BRACCIOLO WAVE / ARMREST WAVE

**Struttura:** legno multistrato imbottito in poliuretano.

**Rivestimento:** con piega decorativa.

**Structure:** plywood padded with polyurethane foam.

**Cover:** with decorative fold.

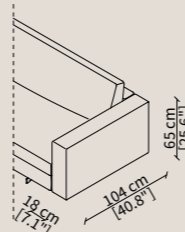

### BRACCIOLO OUT / ARMREST OUT

**Struttura:** legno multistrato imbottito in poliuretano con trapuntino in piuma d'oca (Assopiuma).

**Structure:** plywood padded with polyurethane foam covered with quilt in goose down (Assopiuma).

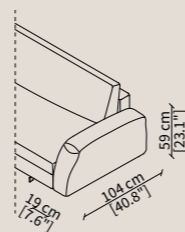

### BRACCIOLO CLASS / ARMREST CLASS

**Struttura:** legno multistrato imbottito in poliuretano.

**Cucitura:** decorativa a pieghe.

**Structure:** plywood padded with polyurethane foam.

**Sewing:** decorative with folds.

## DAVIS BRACCIOLI / ARMRESTS

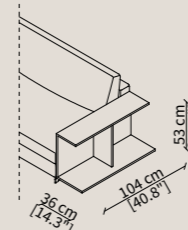

### BRACCIOLO BOOK 27-36 / ARMREST BOOK 27-36

**Struttura:** legno impiallacciato frassino nelle colorazioni della collezione.

**Structure:** wood veneer ash in the colours of the collection.

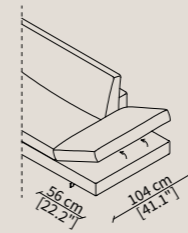

### BRACCIOLO FLAT 36-56 / ARMREST FLAT 36-56

**Base:** legno multistrato imbottito in poliuretano.

**Cuscino:** rialzabile; imbottito in poliuretano e piuma d'oca.

**Base:** plywood padded with polyurethane foam.

**Cushion:** adjustable in height; padded with polyurethane foam and goose down.

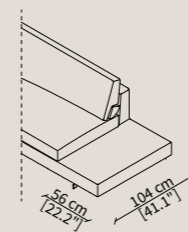

### BRACCIOLO TOP FLAT 36-56 / ARMREST TOP FLAT 36-56

**Struttura:** legno multistrato imbottito in poliuretano espanso indeformabile rivestito in tessuto protettivo accoppiato.

**Structure:** plywood padded with non-deformable polyurethane foam covered with doubled protective fabric.

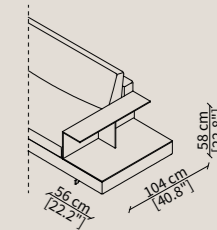

### BRACCIOLO CASE 36-56 / ARMRESTCASE 36-56

**Base:** legno multistrato imbottito in poliuretano.

**Libreria:** metallo rivestito in cuoio o pelle.

**Base:** plywood padded with polyurethane foam.

**Bookcase:** in metal covered in hide-leather art. Cuoio or leather.

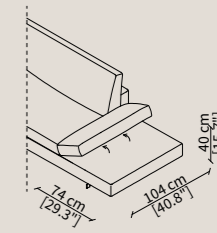

### BRACCIOLO FLAT 74 / ARMREST FLAT 74

**Base:** legno multistrato imbottito in poliuretano.

**Cuscino:** rialzabile; imbottito in poliuretano e piuma d'oca.

**Base:** plywood padded with polyurethane foam.

**Cushion:** adjustable in height; padded with polyurethane foam and goose down.

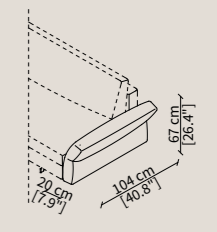

### BRACCIOLO SWING / ARMREST SWING

**Struttura:** legno multistrato e meccanismo reclinabile imbottiti in poliuretano espanso indeformabile rivestito in fibra sintetica termolegata con vellutino.

**Structure:** plywood and metal reclining mechanism padded with non-deformable polyurethane foam covered with synthetic fibre thermo-bonded with velveteen.

## DAVIS PIEDINI / FEET



### PIEDINO L / FOOT L

Piedino in metallo disponibile in differenti finiture.

Metal foot available in different finishes.

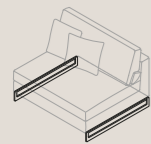

### PIEDINO R / FOOT R

Piedino in metallo disponibile in differenti finiture.

Metal foot available in different finishes.

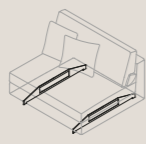

### PIEDINO P / FOOT P

Piedino in metallo disponibile in differenti finiture.

Metal foot available in different finishes.



### PIEDINO M / FOOT M

Piedino in metallo disponibile in differenti finiture.

Metal foot available in different finishes.

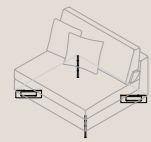

### PIEDINO T / FOOT T

Piedino in metallo disponibile in differenti finiture.

Metal foot available in different finishes.

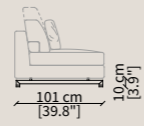
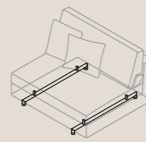

## DAVIS SEDUTE / SEATS



### GOOSE

Cuscino seduta con inserto in poliuretano indeformabile e trapuntino in piuma d'oca. La seduta, realizzata in un pezzo unico, assumerà con l'uso un aspetto più morbido e vissuto.

Seat cushion with core in non-deformable polyurethane foam covered with goose down quilt. The seat, realized in one piece, will look softer with everyday use.

### POLMD

Cuscino seduta in poliuretano espanso indeformabile media densità e fibra sintetica ricoperti con fodera in cotone. La seduta, realizzata in un pezzo unico, assumerà con l'uso un aspetto più morbido e vissuto.

Seat cushion in medium density non-deformable polyurethane foam and synthetic fibre layer covered with cotton fabric. The seat, realized in one piece, will look softer with everyday use.

### POLHD

Cuscino seduta in poliuretano espanso indeformabile alta densità e fibra sintetica ricoperti con fodera in cotone. La seduta, realizzata in un pezzo unico, assumerà con l'uso un aspetto più morbido e vissuto.

Seat cushion in hard density non-deformable polyurethane foam and synthetic fibre layer covered with cotton fabric. The seat, realized in one piece, will look softer with everyday use.

## DAVIS SCHIENALI / BACK CUSHIONS



### A.

Versione con cuscino schienale in posizione standard. Seduta profondità **60 cm.**

Version with back cushion in standard position. Seat **60 cm** deep.

### B.

Versione con cuscino schienale rialzato. Seduta profondità **71 cm.**

Raised back cushion version. Seat **71 cm** deep.

Il divano Davis è caratterizzato da un cuscino schienale "patent pending" con movimento integrato, che nella versione rialzata incrementa lo spazio di seduta donando maggior comfort.

The Davis sofa is characterised by a back cushion "patent pending" with integrated movement, which is the raised version, increases the seating space and provides greater comfort.

## DAVIS TOP FLAT ACCESSORI / TOP FLAT ACCESSORIES

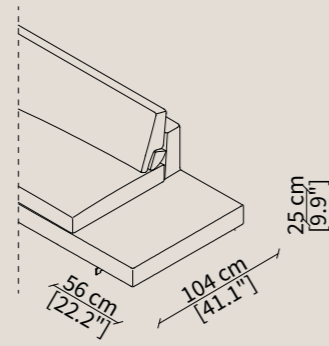

Il bracciolo Top Flat permette il posizionamento di una serie di accessori per realizzare composizioni multifunzionali e soddisfare le diverse esigenze di ogni stanza.

The armrest Top Flat allows the fitting of a series of accessories to create multifunctional compositions and meet the different needs of every environment.



### TOP WOOD

Top in legno disponibile in due misure per essere appoggiato sul bracciolo Top Flat.

Wooden top available in two sizes to be placed on the Top Flat armrest.



### TOP MARBLE

Top in marmo disponibile in due misure per essere appoggiato sul bracciolo Top Flat.

Marble top available in two sizes to be placed on the Top Flat armrest.

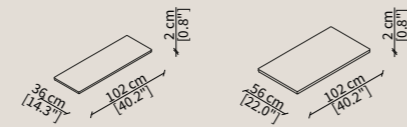
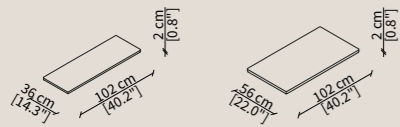

### TRAY

Vassoio disponibile in due misure rivestito in cuoio per essere appoggiato sul bracciolo Top Flat.

Tray available in two sizes covered in hide-leather to be placed on the Top Flat armrest.



### BOX

Elemento in legno disponibile in due misure per posizionamento sul bracciolo Top Flat.

Wooden element available in two sizes to be placed on the Top Flat armrest.

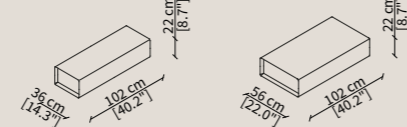
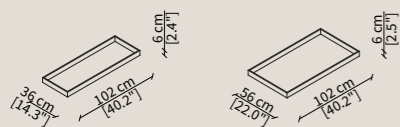

## DAVIS POUF ACCESSORI / POUF ACCESSORIES

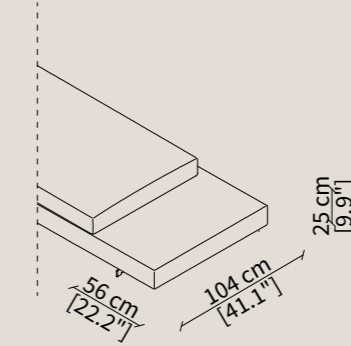

Al Davis pouf è possibile coordinare i braccioli Top Flat e Flat per soluzioni arredative inaspettate e innovative.

The pouf Davis could be used with armrests Top Flat and Flat for unexpected and innovative solutions.



### TOP WOOD

Top in legno disponibile in due misure per essere appoggiato sul bracciolo Top Flat.

Wooden top available in two sizes to be placed on the Top Flat armrest.



### TOP MARBLE

Top in marmo disponibile in due misure per essere appoggiato sul bracciolo Top Flat.

Marble top available in two sizes to be placed on the Top Flat armrest.

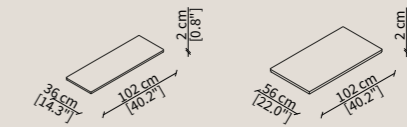
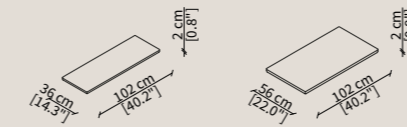

### TRAY

Vassoio disponibile in due misure rivestito in cuoio per essere appoggiato sul bracciolo Top Flat.

Tray available in two sizes covered in hide-leather to be placed on the Top Flat armrest.



### BOX

Elemento in legno disponibile in due misure per posizionamento sul bracciolo Top Flat.

Wooden element available in two sizes to be placed on the Top Flat armrest.

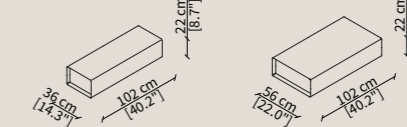
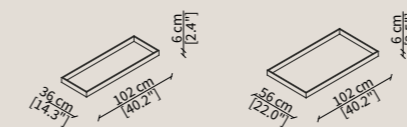

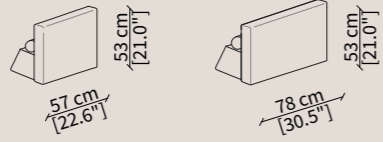

### SCHIENALE LIBERO POSIZIONAMENTO / FREESTANDING BACKREST WITH CUSHION

Lo schienale libero posizionamento, disponibile in due misure, può essere utilizzato in svariate situazioni per innovative soluzioni arredative.

The free-standing backrest, available in two sizes, could be used in different situations for innovative furnishing solutions.

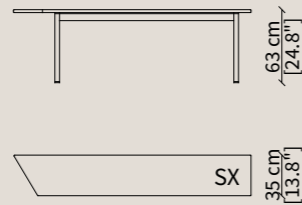

### DAVIS FLY

L'elemento Davis Fly è un tavolo sagomato per l'utilizzo coordinato agli elementi terminali Fly per soluzioni retrodivano innovative e funzionali.

The Davis Fly element is a shaped table to be used coordinated to the Fly terminal elements for back-sofas innovative and functional solutions.

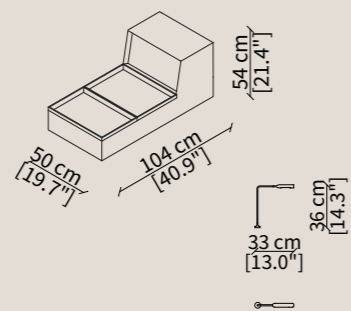

### DAVIS CABINET - DAVIS LAMP

Elemento Cabinet in legno disponibile in varie finiture coordinato su richiesta con una lampada.

Cabinet element in wood available in different finishes and coordinated on request with a lamp.



### SCHIENALE BACK / BACKREST CUSHION

Lo schienale Back della collezione Davis è un elemento modulare innovativo che permette di risolvere situazioni angolari utilizzando al meglio lo spazio e garantendo l'imbattibile comfort della collezione.

The Back element from the Davis collection is an innovative modular element, which allows to solve corner situation by using the space at the best and by granting the unbeatable comfort of the collection.

### DETTAGLI DELLO SCHIENALE BACK / DETAILS OF BACKREST BACK

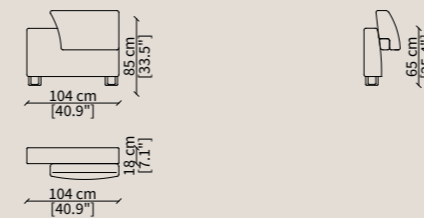

**BACK:** Elemento con le stesse caratteristiche dello schienale per essere usato nelle composizioni ad angolo.

**BACK:** Element with same characteristics as the backrest, to be used in corner compositions.

### ESEMPI DI COMPOSIZIONE AD ANGOLO / EXAMPLES OF CORNER COMPOSITIONS

Le composizioni ad angolo possono essere così realizzate:  
Corner composition can be built as follows:

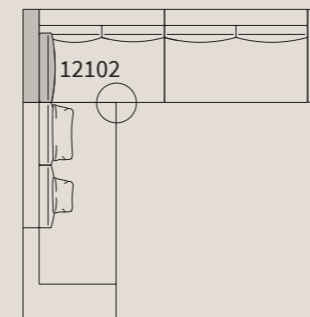

1. creando un angolo unendo qualsiasi elemento allo schienale **BACK**.

1. by building a corner joining any elements to the backrest **BACK**.

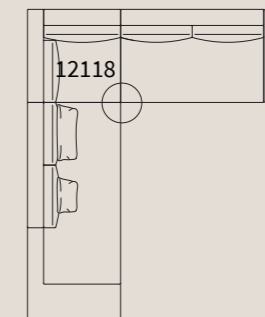

2. utilizzando l'angolo (art. **12118**) per un allineamento preciso delle sedute.

2. by using the corner (art. **12118**) for a perfect alignment of the seats.

**DAVIS SOFA**  
Design R&D Frigerio

**SCHIENALE STANDARD / BACK CUSHION STANDARD / h. 78 cm**

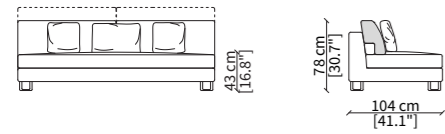

**SCHIENALE RIALZATO / RAISED BACK CUSHION / h. 93 cm**

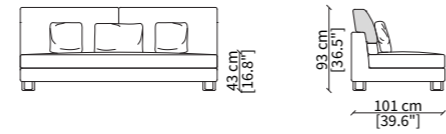

**BRACCIOLI / ARMRESTS**

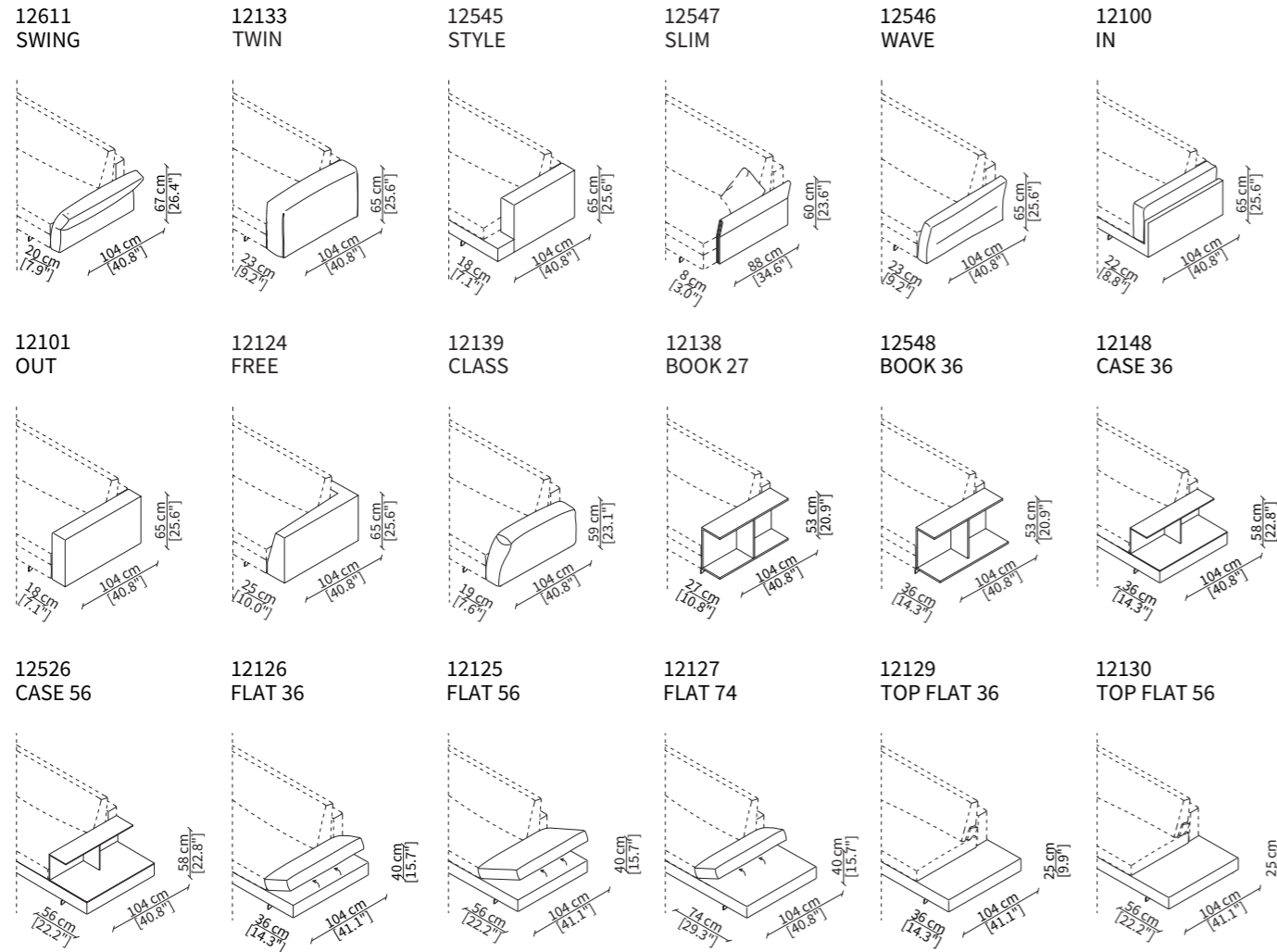

**ELEMENTI CENTRALI / CENTRAL ELEMENTS**

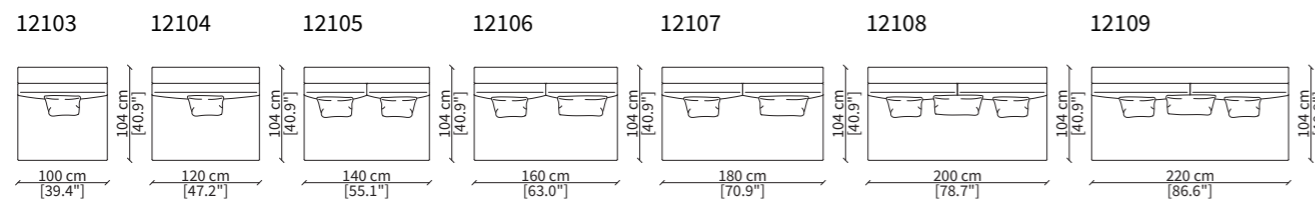

Dimensioni espresse in cm se non diversamente indicato.  
L'Azienda si riserva il diritto di apportare modifiche ai modelli senza preavviso.

Tolleranza sulle misure indicate di +/- 2%.  
Dimensions in centimeter if not differently indicated.

**DAVIS SOFA**  
Design R&D Frigerio

**ELEMENTI DORMEUSE / DORMEUSE ELEMENTS**

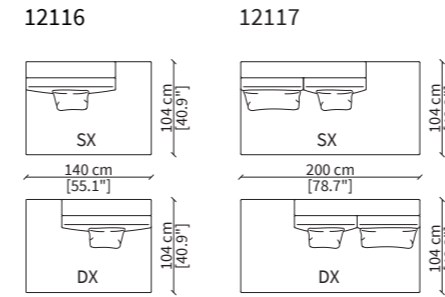

**ELEMENTI DORMEUSE POUF / DORMEUSE POUF ELEMENTS**

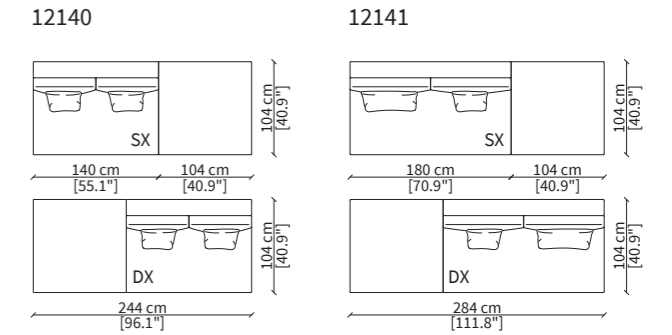

**ELEMENTI DORMEUSE CON TOP / DORMEUSE ELEMENTS WITH TOP**

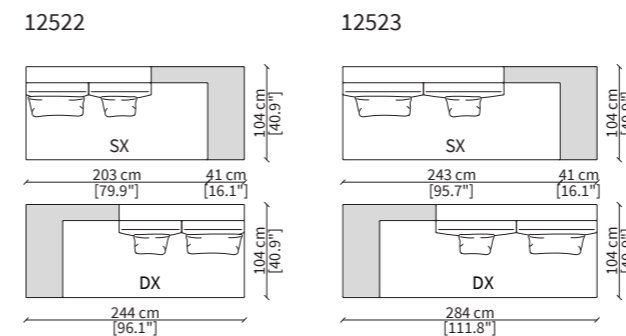

**ELEMENTO COMFORT / ELEMENT COMFORT**

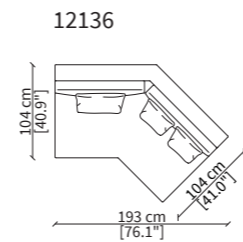

**ELEMENTO DORMEUSE COMFORT / DORMEUSE COMFORT ELEMENT**

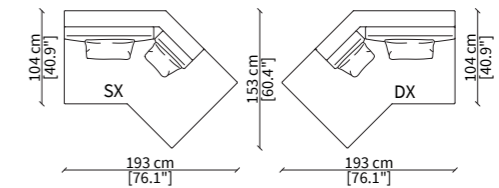

**ELEMENTO TERMINALE PER FLY / TERMINAL ELEMENT FOR FLY**

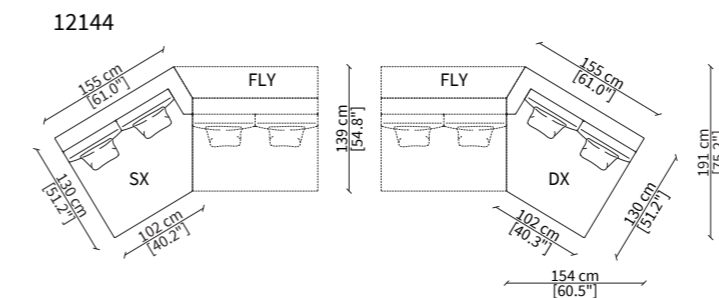

Dimensioni espresse in cm se non diversamente indicato.  
L'Azienda si riserva il diritto di apportare modifiche ai modelli senza preavviso.

Tolleranza sulle misure indicate di +/- 2%.  
Dimensions in centimeter if not differently indicated.

**DAVIS SOFA**  
Design R&D Frigerio

## CHAISES LONGUE CENTRALI / CENTRAL CHAIRES LONGUE

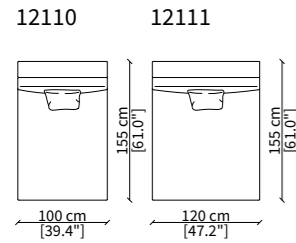

## CHAISES LONGUE CON BRACCIOLO SWING / CHAIRES LONGUE WITH SWING ARMREST

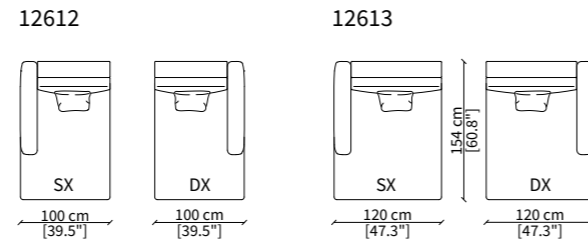

## CHAISES LONGUE CON BRACCIOLO TWIN / CHAIRES LONGUE WITH TWIN ARMREST

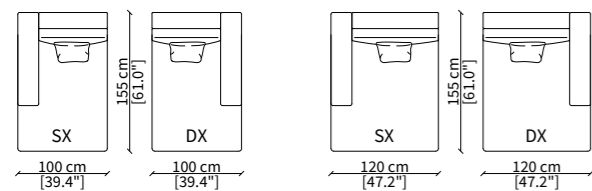

## CHAISES LONGUE CON BRACCIOLO STYLE / CHAIRES LONGUE WITH STYLE ARMREST

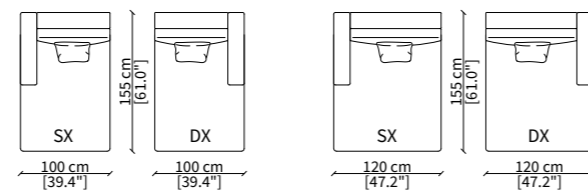

## CHAISES LONGUE CON BRACCIOLO SLIM / CHAIRES LONGUE WITH SLIM ARMREST

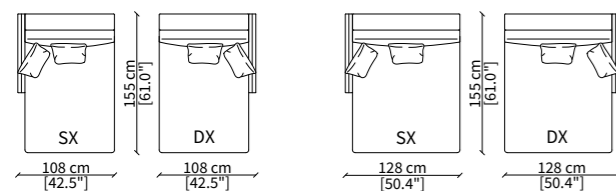

## CHAISES LONGUE CON BRACCIOLO WAVE / CHAIRES LONGUE WITH WAVE ARMREST

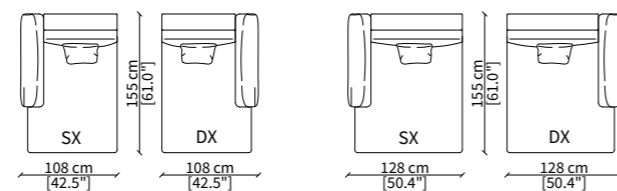

## CHAISES LONGUE CON BRACCIOLO IN / CHAIRES LONGUE WITH IN ARMREST

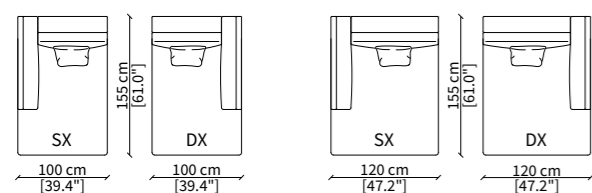

## CHAISES LONGUE CON BRACCIOLO OUT / CHAIRES LONGUE WITH OUT ARMREST

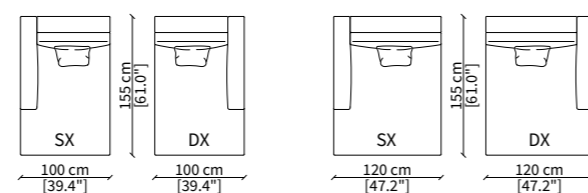

## CHAISES LONGUE CON BRACCIOLO FREE / CHAIRES LONGUE WITH FREE ARMREST

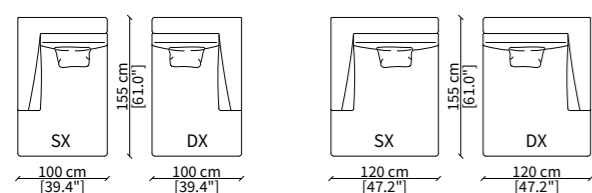

## CHAISES LONGUE CON BRACCIOLO CLASS / CHAIRES LONGUE WITH CLASS ARMREST

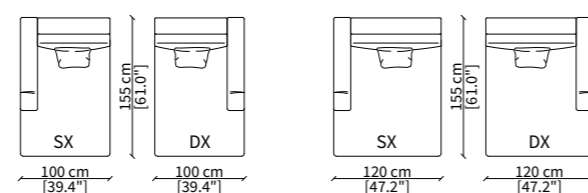

Dimensioni espresse in cm se non diversamente indicato.  
L'Azienda si riserva il diritto di apportare modifiche ai modelli senza preavviso.

Tolleranza sulle misure indicate di +/- 2%.  
Dimensions in centimeter if not differently indicated.

**DAVIS SOFA**  
Design R&D Frigerio

## ELEMENTO ANGOLO / CORNER ELEMENT

12118

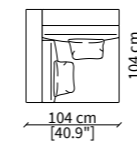

## SCHIENALE / BACK

12102

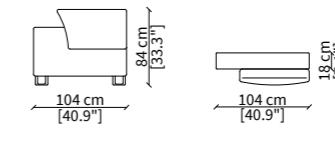

## POUFS

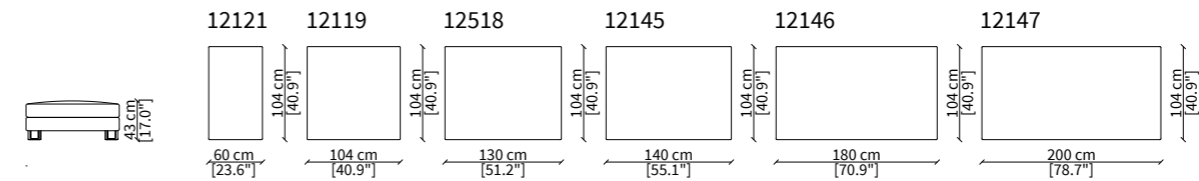

## TOPS

12430

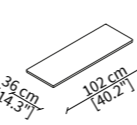

## VASSOI / TRAYS

12431

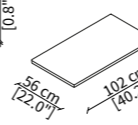

12131

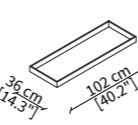

12132

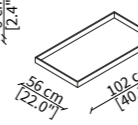

## BOX

12432

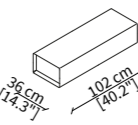

12433

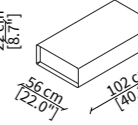

## CABINET

12525

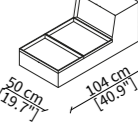

## LAMP

TYDA

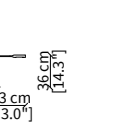

## FLY

13158

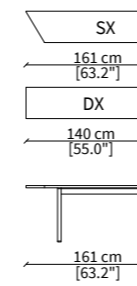

13159

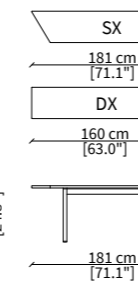

13160

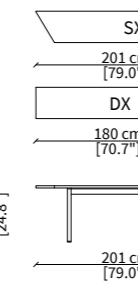

Dimensioni espresse in cm se non diversamente indicato.  
L'Azienda si riserva il diritto di apportare modifiche ai modelli senza preavviso.

Tolleranza sulle misure indicate di +/- 2%.  
Dimensions in centimeter if not differently indicated.

**DAVIS SOFA**  
Design R&D Frigerio

## DETTAGLI DELLO SCHIENALE BACK / DETAILS OF BACKREST BACK

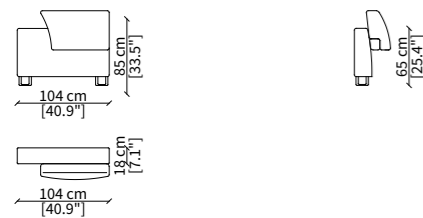

**BACK:** Elemento con le stesse caratteristiche dello schienale per essere usato nelle composizioni ad angolo.

**BACK:** Element with same characteristics as the backrest, to be used in corner compositions.

## ESEMPI DI COMPOSIZIONE AD ANGOLO / EXAMPLES OF CORNER COMPOSITIONS

Le composizioni ad angolo possono essere così realizzate:  
Corner composition can be built as follows:

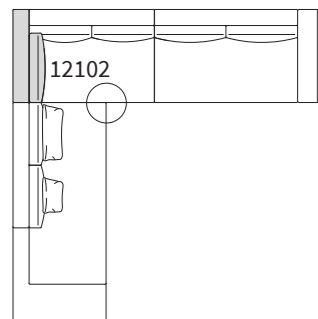

1. creando un angolo unendo qualsiasi elemento allo schienale **BACK**.

1. by building a corner joining any elements to the backrest **BACK**.

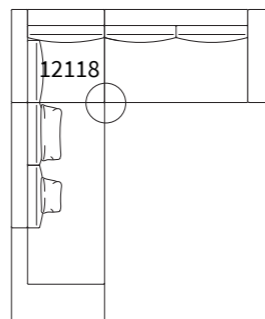

2. utilizzando l'angolo (art. **12118**) per un allineamento preciso delle sedute.

2. by using the corner (art. **12118**) for a perfect alignment of the seats.

**DAVIS SOFA**  
Design R&D Frigerio

## COMPOSIZIONE 1 / COMPOSITION 1

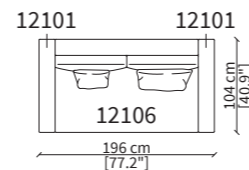

CODICI / CODES: **12101 x 2, 12106**

## COMPOSIZIONE 2 / COMPOSITION 2

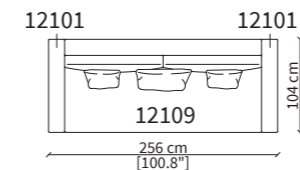

CODICI / CODES: **12101 x 2, 12109**

## COMPOSIZIONE 3 / COMPOSITION 3

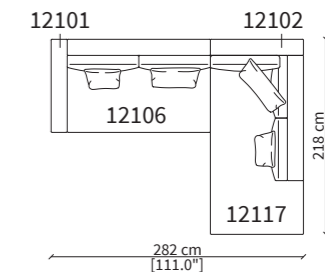

CODICI / CODES: **12101, 12106, 12102, 12117**

## COMPOSIZIONE 4 / COMPOSITION 4

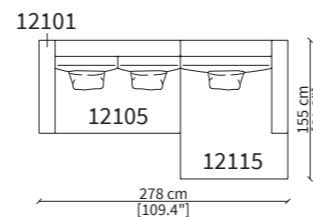

CODICI / CODES: **12101, 12105, 12115**

## COMPOSIZIONE 5 / COMPOSITION 5

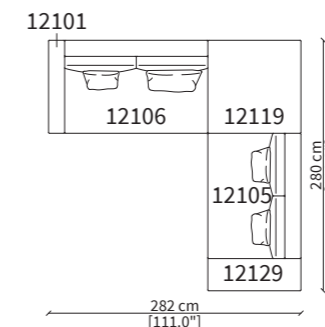

CODICI / CODES: **12101, 12106, 12119, 12105, 12129**

## COMPOSIZIONE 6 / COMPOSITION 6

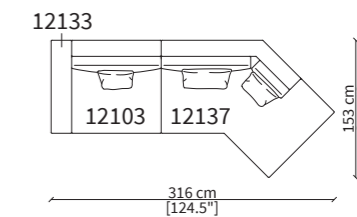

CODICI / CODES: **12133, 12103, 12137**

## COMPOSIZIONE 7 / COMPOSITION 7

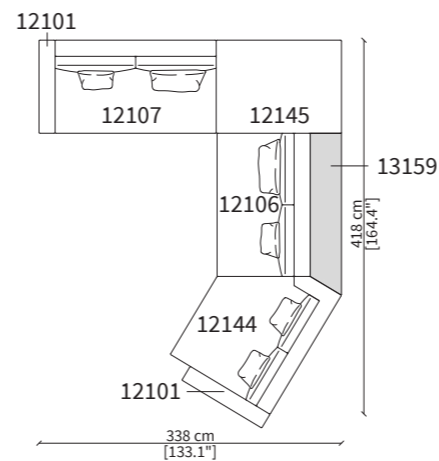

CODICI / CODES: **12101 x 2, 12107, 12145, 12106, 13159, 12144**

## COMPOSIZIONE 8 / COMPOSITION 8

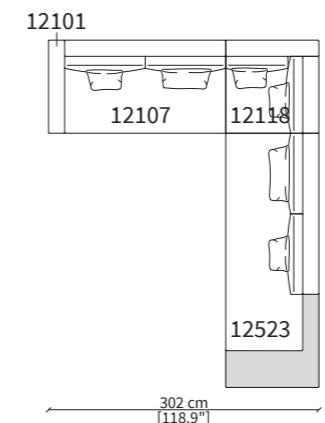

CODICI / CODES: **12101, 12107, 12118, 12523**

## COMPOSIZIONE 9 / COMPOSITION 9

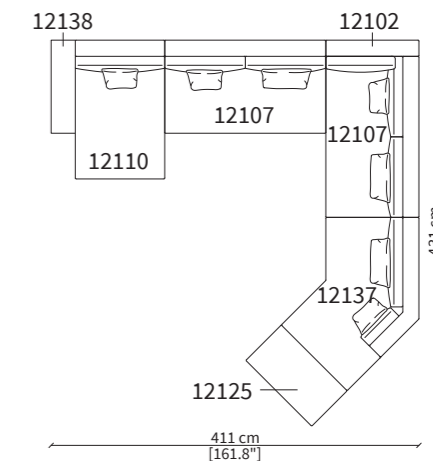

CODICI / CODES: **12138, 12110, 12107 x 2, 12102, 12137, 12125**

Per la gamma completa di materiali è possibile consultare il nostro sito web [www.frigerio.com](http://www.frigerio.com)  
The full range of materials can be found on our website at [www.frigerio.com](http://www.frigerio.com).

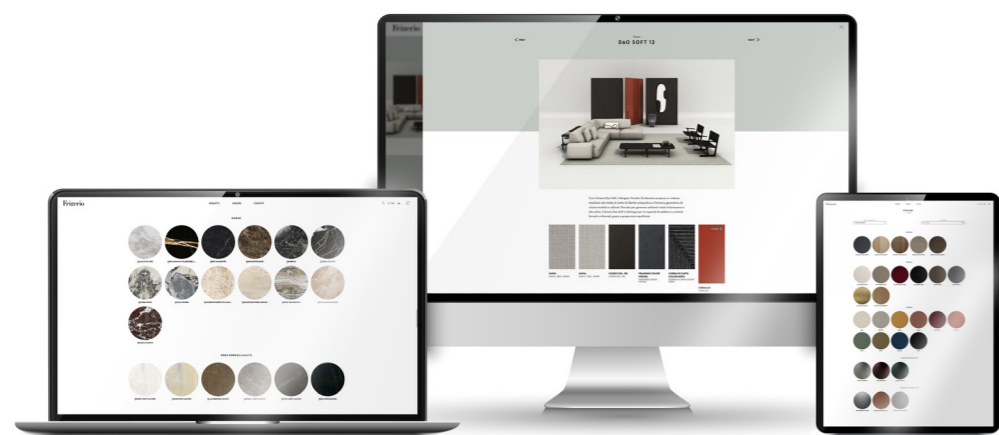

[WWW.FRIGERIO.COM](http://WWW.FRIGERIO.COM)

# Frigerio

Via Sant'Agata 63  
22066 Mariano Comense (CO) - Italy  
Tel. +39 031 5481225  
[info@frigerio.com](mailto:info@frigerio.com)  
[www.frigerio.com](http://www.frigerio.com)